

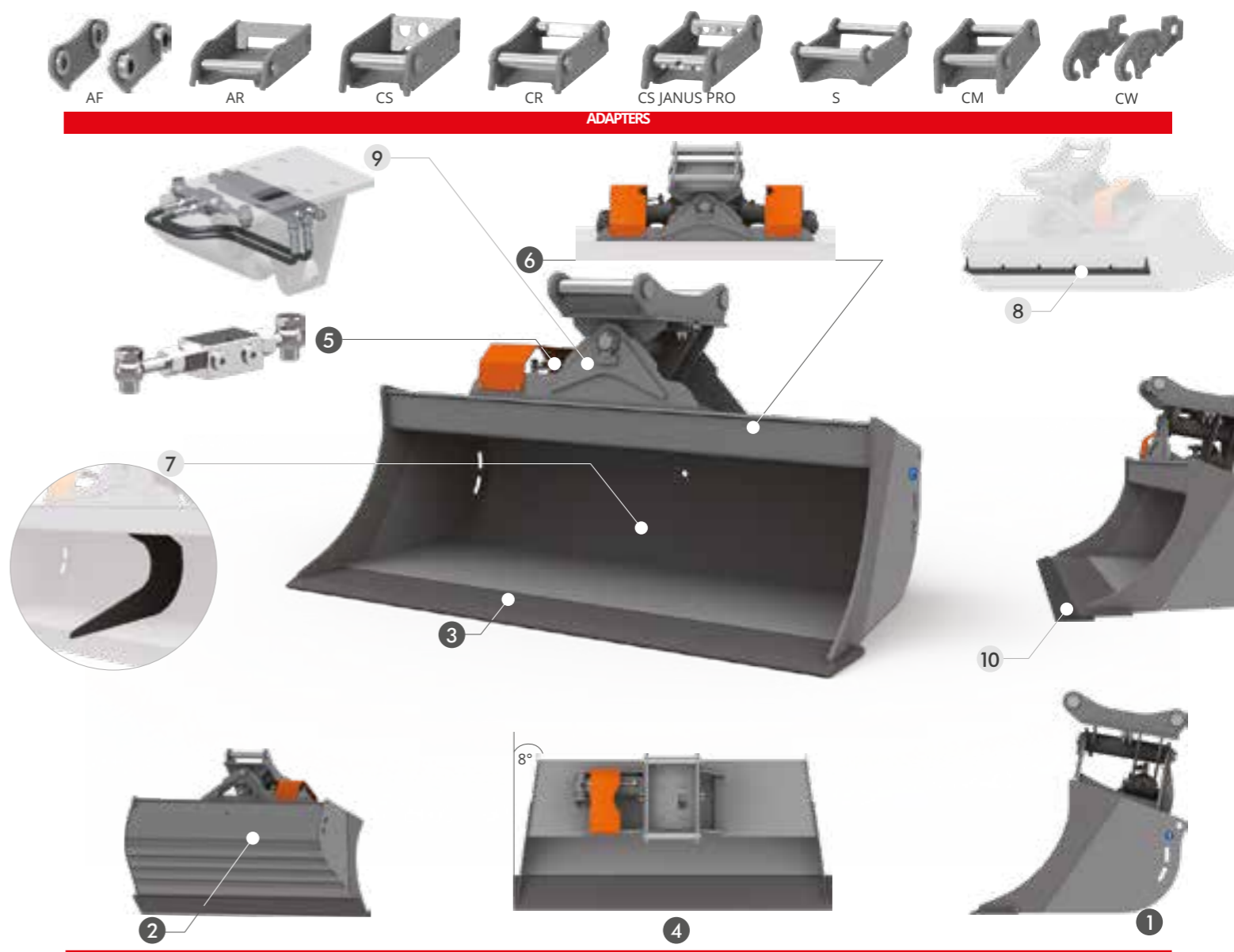

HB400



STANDARD TECHNICAL FEATURES

- 1 ELONGATED PROFILE**
- 2 REINFORCING STRIPS**
THE HORIZONTAL REINFORCING STRIPS ON THE BUCKET'S REAR AND BOTTOM PROTECT THE BUCKET FROM WEAR AND INCREASE ITS RESISTANCE.
- 3 HB400 CUTTING EDGE**
- 4 8° CONE SHAPE**
- 5 BLOCK VALVE**
IT ALLOWS TO KEEP THE BUCKET POSITIONING DURING THE WORKING PHASE.
- 6 DOUBLE CYLINDER FOR SQS 65 8° HD AND SQS 70 8° HD MODELS**

OPTIONAL

- 7 BEZEL**
IT ENSURES A HIGHER STRUCTURAL RESISTANCE. **HIGHLY RECOMMENDED WITH BUCKETS 1400MM WIDE OR MORE.**
- 8 REAR RAZOR**
WHEN THE MACHINE'S ARM IS KEPT CLOSED, IT ALLOWS TO FINISH SURFACES EVENLY.
- 9 PIPE KIT**
OPTIONAL KIT INSTALLED ON THE BUCKET FOR THE FEEDING OF THE HYDRAULIC CYLINDER. IT ALLOWS THE USE OF TWO OUTLETS ON THE RIGHT AND TWO OUTLETS ON THE LEFT FOR THE HYDRAULIC CONNECTION TO THE MACHINE REDUCING THE INSTALLATION TIMES. THE CONNECTING PIPES ARE NOT SUPPLIED.
- 10 HB500 WELDED ADDITIONAL CUTTING EDGE**
RECOMMENDED TO WORK ON PARTICULARLY ABRASIVE SOILS.

ITS TILTING SYSTEM ENABLES TO TILT IT BY 45° ON BOTH SIDES. ITS ELONGATED SHAPE AVOIDS THAT THE GROUND STICKS TO THE BUCKET'S SIDE WALLS AND SIMPLIFIES THE DISCHARGE OF LOAMY AND WET MATERIALS. USED MAINLY TO CLEAN AND LEVEL STREETS, DITCHES AND DIKES. HB400 ANTI-WEAR ELEMENTS REINFORCE THE MOST STRESSED PARTS. THE BLADE IS MADE OF HB400 FOR A HIGHER RESISTANCE TO WEAR.

THE INSTALLATION OF BEZELS IS HIGHLY RECOMMENDED FOR BUCKETS WIDER THAN 1400 MM, IN ORDER TO AVOID DAMAGES TO THE BUCKET IN CASE OF HEAVY DUTY JOBS OR WITH PARTICULARLY HARD TERRAINS:

- **WIDTH FROM 1400 TO 1500 MM: NR. 1 BEZEL**
- **WIDTH FROM 1600 TO 1600 MM: NR. 2 BEZELS**
- **WIDTH FROM 1800 TO 2200 MM: NR. 3 BEZELS**

MOD.	SQS 30 8°GD	SQS 35 8°GD	SQS 40 8°GD	SQS 45 8°GD	SQS 50 8°GD	SQS 55 8°GD	SQS 60 8°GD	SQS 65 8°GD	SQS 70 8°GD
TONS (LB)	0,8 - 1,5 (1764 - 3307)	1,5 - 2,0 (3307 - 4409)	2,0 - 3,0 (4409 - 6614)	3,0 - 4,0 (6614 - 8818)	4,0 - 6,0 (8818 - 13228)	6,0 - 7,5 (13228 - 16535)	7,5 - 12,0 (16535 - 26456)	12,0 - 18,0 (26456 - 39683)	18,0 - 22,0 (39683 - 48502)

SQS30 8°GD MACHINE WEIGHT 0,8 - 1,5 (1764 - 3307 lb)

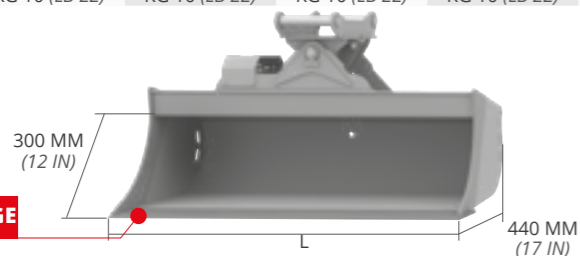

HB400 CUTTING EDGE

L MM (IN)	WEIGHT KG* (LB*)	CAP. SAE L (GAL)	ADAPTERS
800 (31)	54 (119)	58 (22,4)	AF - AR - CS CR - S - CM CW - CS JANUS PRO

OPTIONAL

8	9	10
REAR RAZOR	PIPE KIT	HB500 WELDED ADDITIONAL CUTTING EDGE

SQS35 8°GD MACHINE WEIGHT 1,5 - 2,0 (3307 - 4409 lb)

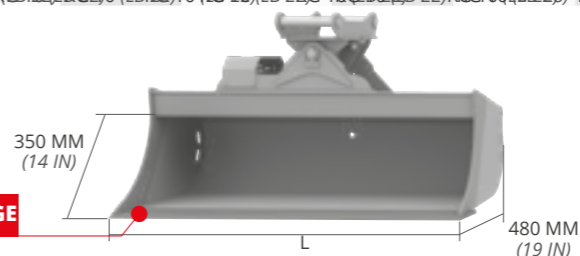

HB400 CUTTING EDGE

L MM (IN)	WEIGHT KG* (LB*)	CAP. SAE L (GAL)	ADAPTERS
900 (35)	74 (163)	85 (22,4)	AF - AR - CS CR - S - CM CW - CS JANUS PRO
1000 (39)	80 (176)	95 (25,1)	AF - AR - CS CR - S - CM CW - CS JANUS PRO
1200 (47)	92 (203)	115 (30,4)	AF - AR - CS CR - S - CM CW - CS JANUS PRO

OPTIONAL

8	9	10
REAR RAZOR	PIPE KIT	HB500 WELDED ADDITIONAL CUTTING EDGE

SQS40 8°GD MACHINE WEIGHT 2,0 - 3,0 (4409 - 6614 lb)

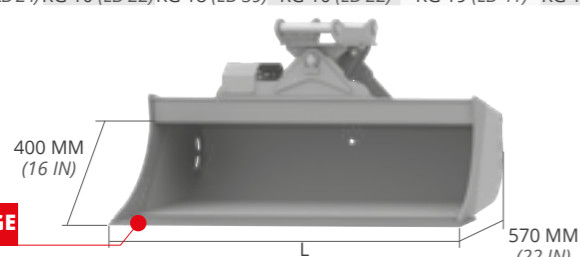

HB400 CUTTING EDGE

L MM (IN)	WEIGHT KG* (LB*)	CAP. SAE L (GAL)	ADAPTERS
1100 (43)	131 (289)	129 (34,1)	AF - AR - CS CR - S - CM CW - CS JANUS PRO
1200 (47)	138 (304)	143 (37,8)	AF - AR - CS CR - S - CM CW - CS JANUS PRO
1400 (55)	154 (340)	157 (41,5)	AF - AR - CS CR - S - CM CW - CS JANUS PRO

OPTIONAL

8	9	10
REAR RAZOR	PIPE KIT	HB500 WELDED ADDITIONAL CUTTING EDGE

SQS45 8°GD MACHINE WEIGHT 3,0 - 4,0 (6614 - 8818 lb)

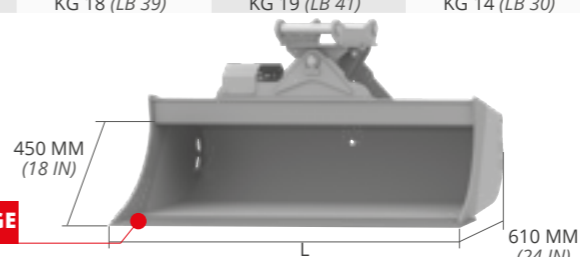

HB400 CUTTING EDGE

L MM (IN)	WEIGHT KG* (LB*)	CAP. SAE L (GAL)	ADAPTERS
1100 (43)	149 (329)	150 (39,6)	AF - AR - CS CR - S - CM CW - CS JANUS PRO
1200 (47)	155 (342)	168 (44,4)	AF - AR - CS CR - S - CM CW - CS JANUS PRO
1400 (55)	176 (389)	204 (53,9)	AF - AR - CS CR - S - CM CW - CS JANUS PRO
1500 (59)	187 (413)	222 (58,6)	AF - AR - CS CR - S - CM CW - CS JANUS PRO

OPTIONAL

8	9	10
REAR RAZOR	PIPE KIT	HB500 WELDED ADDITIONAL CUTTING EDGE

* weight of the tank excluding attachment

* weight of the tank excluding attachment

SQS50 8°GD MACHINE WEIGHT 4,0 - 6,0 (8818 - 13228 lb)

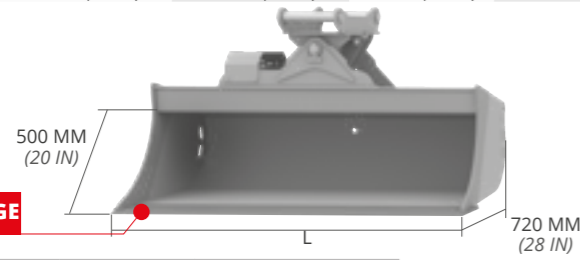

HB400 CUTTING EDGE

OPTIONAL

L MM (IN)	WEIGHT KG* (LB*)	CAP. SAE L (GAL)	ADAPTERS
1200 (47)	201 (444)	210 (55,5)	AF - AR - CS CR - S - CM CW - CS JANUS PRO
1300 (51)	212 (468)	230 (60,8)	AF - AR - CS CR - S - CM CW - CS JANUS PRO
1400 (55)	223 (492)	250 (66,0)	AF - AR - CS CR - S - CM CW - CS JANUS PRO
1600 (63)	245 (541)	290 (76,7)	AF - AR - CS CR - S - CM CW - CS JANUS PRO

7	8	9	10
BEZEL	REAR RAZOR	PIPE KIT	HB500 WELDED ADDITIONAL CUTTING EDGE

SQS55 8°GD MACHINE WEIGHT 6,0 - 7,5 (13228 - 16535 lb)

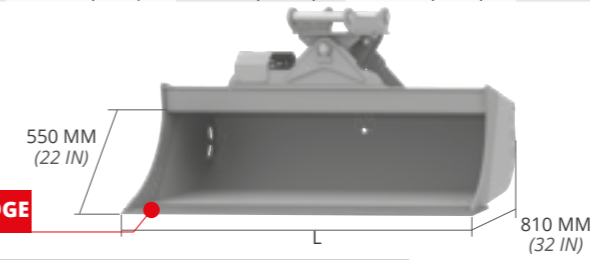

HB400 CUTTING EDGE

OPTIONAL

L MM (IN)	WEIGHT KG* (LB*)	CAP. SAE L (GAL)	ADAPTERS
1300 (51)	274 (605)	300 (79,2)	AF - AR - CS CR - S - CM CW - CS JANUS PRO
1400 (55)	288 (635)	325 (85,6)	AF - AR - CS CR - S - CM CW - CS JANUS PRO
1500 (59)	302 (666)	350 (92,4)	AF - AR - CS CR - S - CM CW - CS JANUS PRO
1600 (63)	315 (695)	375 (99,1)	AF - AR - CS CR - S - CM CW - CS JANUS PRO
1800 (71)	342 (754)	425 (112,3)	AF - AR - CS CR - S - CM CW - CS JANUS PRO

7	8	9	10
BEZEL	REAR RAZOR	PIPE KIT	HB500 WELDED ADDITIONAL CUTTING EDGE

SQS60 8°GD MIDI MACHINE WEIGHT 7,5 - 12,0 (16535 - 26456 lb)

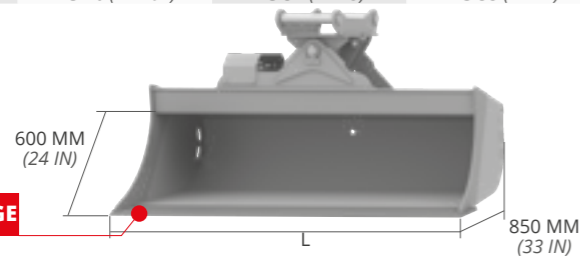

HB400 CUTTING EDGE

OPTIONAL

L MM (IN)	WEIGHT KG* (LB*)	CAP. SAE L (GAL)	ADAPTERS
1400 (55)	314 (699)	360 (95,1)	AF - CS CR - S - CM CW - CS JANUS PRO
1500 (59)	329 (725)	400 (105,7)	AF - CS CR - S - CM CW - CS JANUS PRO
1600 (63)	344 (759)	430 (113,6)	AF - CS CR - S - CM CW - CS JANUS PRO
1800 (71)	372 (820)	490 (129,4)	AF - CS CR - S - CM CW - CS JANUS PRO
2000 (79)	407 (897)	550 (145,3)	AF - CS CR - S - CM CW - CS JANUS PRO

7	8	9	10
BEZEL	REAR RAZOR	PIPE KIT	HB500 WELDED ADDITIONAL CUTTING EDGE

SQS65 8°GD EXCAVATOR MACHINE WEIGHT 12,0 - 18,0 t (26456 - 39683 lb)

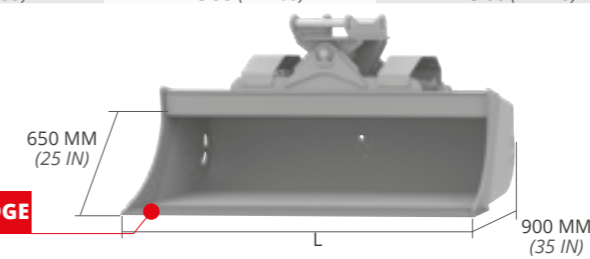

HB400 CUTTING EDGE

OPTIONAL

L MM (IN)	WEIGHT KG* (LB*)	CAP. SAE L (GAL)	ADAPTERS
1400 (55)	421 (928)	466 (123,1)	AF - S - CM CS - CW CS JANUS PRO
1500 (59)	442 (974)	500 (132,1)	AF - S - CM CS - CW CS JANUS PRO
1600 (63)	462 (1019)	534 (141,1)	AF - S - CM CS - CW CS JANUS PRO
1800 (71)	503 (1109)	602 (159,1)	AF - S - CM CS - CW CS JANUS PRO
2000 (79)	543 (1197)	670 (176,1)	AF - S - CM CS - CW CS JANUS PRO

7	8	9	10
BEZEL	REAR RAZOR	PIPE KIT	HB500 WELDED ADDITIONAL CUTTING EDGE

* weight of the tank excluding attachment

* weight of the tank excluding attachment

SQS70 8°GD MACHINE WEIGHT 18,0 - 22,0 t (39683 - 48502 lb)

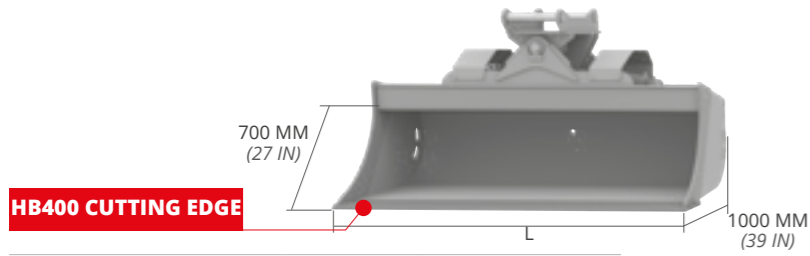

L MM (IN)	WEIGHT KG* (LB*)	CAP. SAE L (GAL)	ADAPTERS
1500 (59)	515 (1136)	600 (158,5)	AF - S - CM CS - CW CS JANUS PRO
1600 (63)	540 (1191)	640 (169,1)	AF - S - CM CS - CW CS JANUS PRO
1800 (71)	590 (1301)	720 (190,2)	AF - S - CM CS - CW CS JANUS PRO
2000 (79)	638 (1406)	800 (211,3)	AF - S - CM CS - CW CS JANUS PRO
2200 (87)	684 (1508)	880 (232,5)	AF - S - CM CS - CW CS JANUS PRO

OPTIONAL

7	8	9	10
BEZEL	REAR RAZOR	PIPE KIT	HB500 WELDED ADDITIONAL CUTTING EDGE



* weight of the tank excluding attachment