



BANDES DE RENFORCEMENT EN HB400 SUR LES POINTS PLUS EXPOSÉS À USURE, TRANCHANTS LATÉRAUX EN FUSION ET CONTRE-LAME RÉVERSIBLE BOULONNÉE POUR RENDRE CE GODET ADAPTÉ AUX TRAVAUX SUR SOLS ABRASIFS.

SUR DES LARGEURS SUPÉRIEURES À 1400 MM, LA POSE DE RENFORT EST FORTEMENT RECOMMANDÉE, AFIN D'ÉVITER D'ENDOMMAGER LE GODET EN CAS DE FORTES CHARGES DE TRAVAIL OU D'UTILISATION SUR SOL PARTICULIÈREMENT DUR:

- LARGEURS DE 1400 À 1500 MM: NR. 1 RENFORT
- LARGEURS DE 1600 À 1600 MM: NR. 2 RENFORTS
- LARGEURS DE 1800 À 2200 MM: NR. 3 RENFORTS

MOD.	SPR35	SPR40	SPR40	SPR45	SPR50	SPR55	MIDI		EXCAVATOR
							SPR60	SPR65 HD	
TONS	1,8 - 2,5	2,0 - 2,5	2,5 - 4,0	4,0 - 5,0	5,0 - 7,5	7,5 - 10,0	10,0 - 12,0	12,0 - 18,0	18,0 - 22,0



ADAPTERS

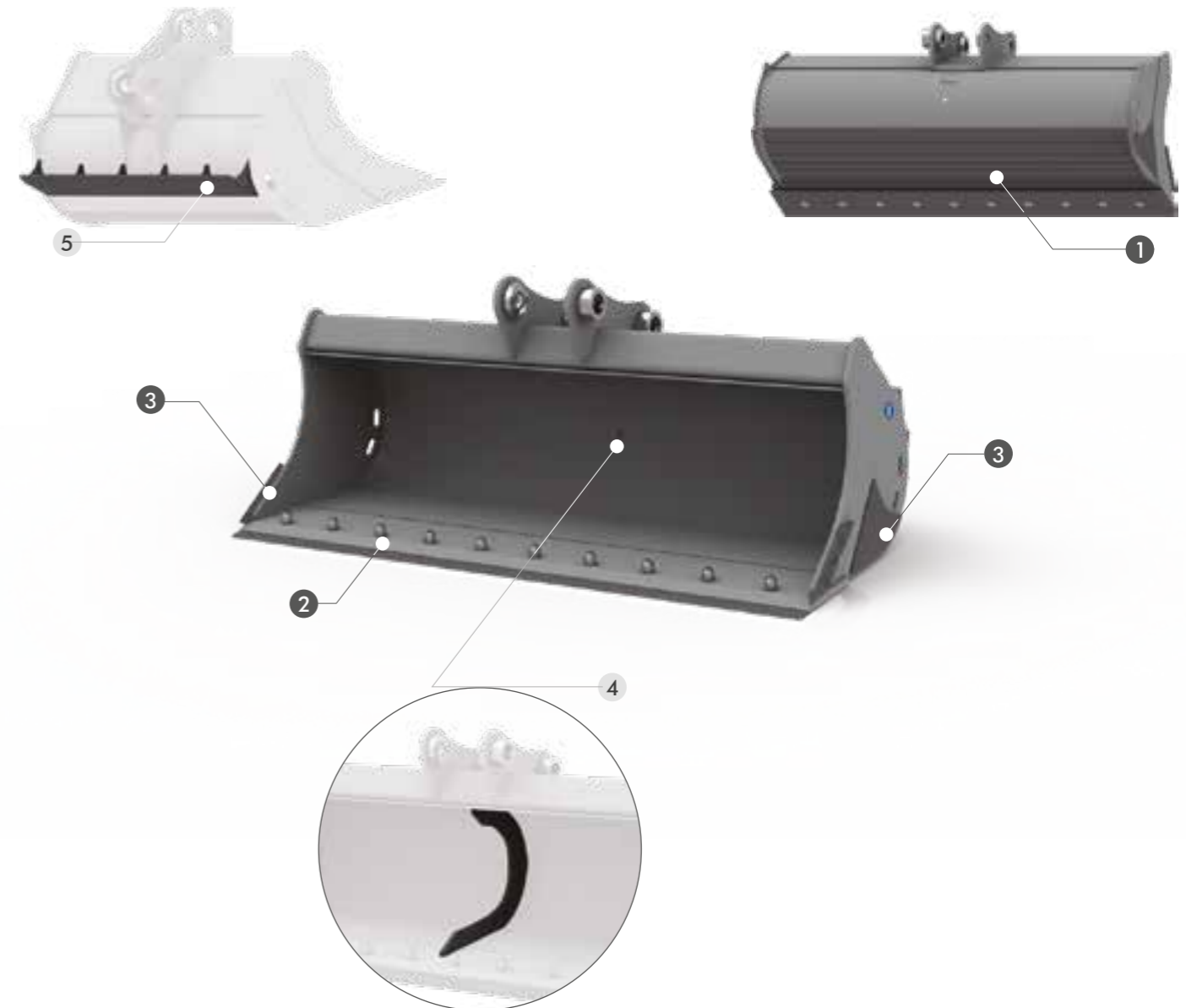

CARACTERISTIQUES TECHNIQUES STANDARD

- 1 BANDES DE RENFORCEMENT HB400**
LES BANDES DE RENFORCEMENT HORIZONTALES PROTÈGENT LE FOND EN AUGMENTANT SA RÉSISTANCE À L'USURE.
- 2 CONTRE-LAME BOULONNÉE HB400**
CONTRE-LAME BOULONNÉE RÉVERSIBLE CONSEILLÉE POUR TRAVAILLER SUR TERRAINS ABRASIFS.
- 3 TRANCHANTS ET BANDES LATÉRALES DE RENFORCEMENT EN FUSION HB400**
RÉALISÉS EN FUSION HB400 ET PLACÉS SUR LES SURFACES LES PLUS EXPOSÉES DONNENT PLUS DE RÉSISTANCE À L'USURE.

EN OPTION

- 4 VIRGULE**
GARANTIT UNE RÉSISTANCE ACCRUE À LA STRUCTURE. **FORTEMENT RECOMMANDÉ DANS LES GODETS D'UNE LARGEUR ÉGALE OU SUPÉRIEURE À 1400 MM.**
- 5 LAME DORSALE**
AVEC LE BRAS MACHINE EN POSITION PLIÉE, ELLE PERMET LA FINITION UNIFORME DES SURFACES.

SPR35 POIDS MACHINE 1,2 - 1,8

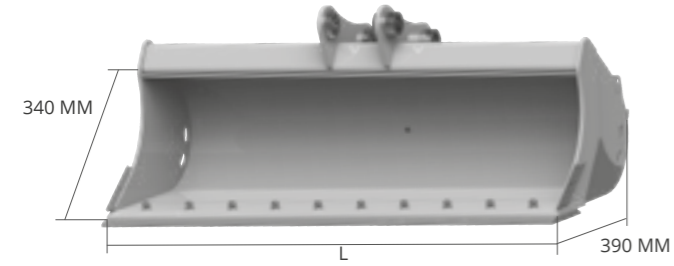
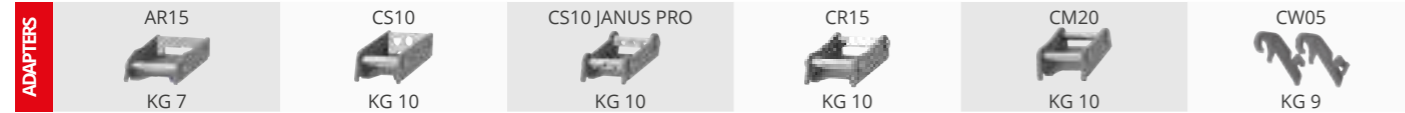

EN OPTION

5
LAME DORSALE

L MM	POIDS KG*	CAP. SAE L	ADAPTERS
800	63	75	AF - AR - CS
			CR - CM
			CW - CS JANUS PRO
1000	76	96	AF - AR - CS
			CR - CM
			CW - CS JANUS PRO
1200	90	117	AF - AR - CS
			CR - CM
			CW - CS JANUS PRO

SPR40 POIDS MACHINE 2,0 - 2,5

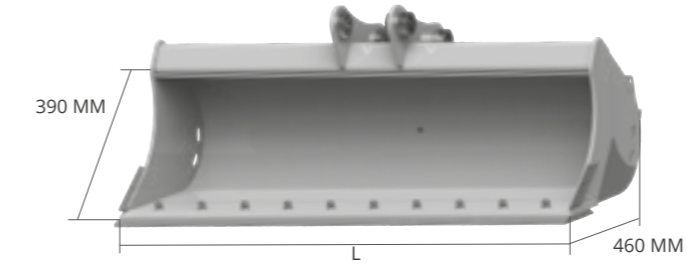

EN OPTION

4
VIRGULE

5
LAME DORSALE

L MM	POIDS KG*	CAP. SAE L	ADAPTERS
1000	108	125	AF - AR - CS
			CR - CM
			CW - CS JANUS PRO
1200	128	154	AF - AR - CS
			CR - CM
			CW - CS JANUS PRO

SPR40 POIDS MACHINE 1,8 - 2,5

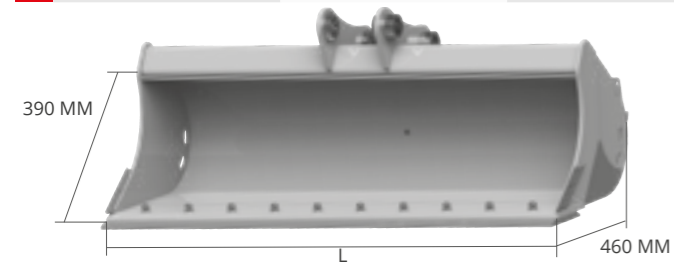
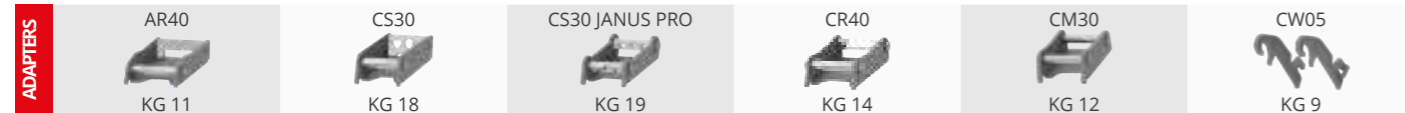

EN OPTION

4
VIRGULE

5
LAME DORSALE

L MM	POIDS KG*	CAP. SAE L	ADAPTERS
1000	108	125	AF - AR - CS
			CR - CM
			CW - CS JANUS PRO
1200	128	154	AF - AR - CS
			CR - CM
			CW - CS JANUS PRO
1400	148	182	AF - AR - CS
			CR - CM
			CW - CS JANUS PRO

SPR45 POIDS MACHINE 4,0 - 5,0

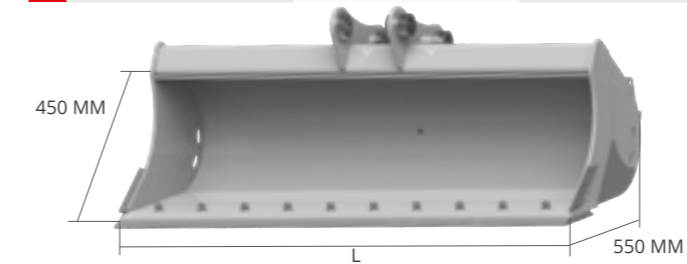
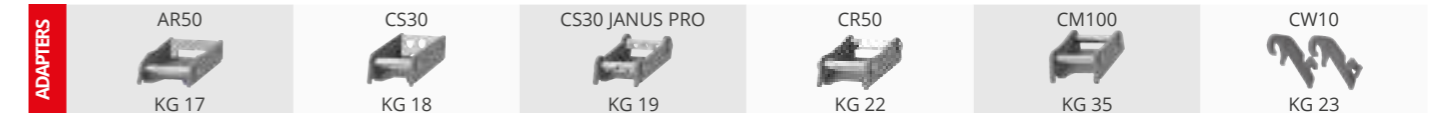

EN OPTION

4
VIRGULE

5
LAME DORSALE

L MM	POIDS KG*	CAP. SAE L	ADAPTERS
1200	160	213	AF - AR - CS
			CR - CM
			CW - CS JANUS PRO
1400	185	254	AF - AR - CS
			CR - CM
			CW - CS JANUS PRO
1500	197	274	AF - AR - CS
			CR - CM
			CW - CS JANUS PRO

* poids cuve sans attache

* poids cuve sans attache

SPR50 POIDS MACHINE 5,0 - 7,5

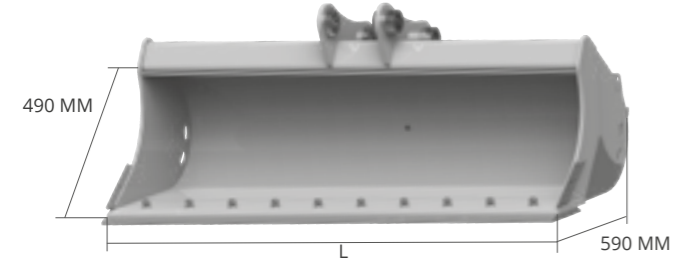

EN OPTION

- 4 VIRGULE
- 5 LAME DORSALE

L MM	POIDS KG*	CAP. SAE L	ADAPTERS
1200	183	250	AF - AR - CS
			CR - CM
			CW - CS JANUS PRO
1400	211	298	AF - AR - CS
			CR - CM
			CW - CS JANUS PRO
1600	239	345	AF - AR - CS
			CR - CM
			CW - CS JANUS PRO
1800	266	392	AF - AR - CS
			CR - CM
			CW - CS JANUS PRO

SPR55 POIDS MACHINE 7,5 - 10,0

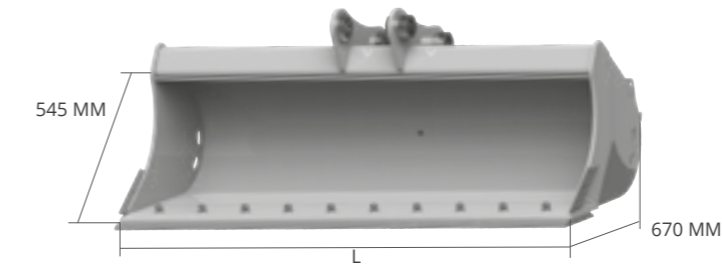

EN OPTION

- 4 VIRGULE
- 5 LAME DORSALE

L MM	POIDS KG*	CAP. SAE L	ADAPTERS
1200	233	326	AF - CS
			CR - CM
			CW - CS JANUS PRO
1400	267	387	AF - CS
			CR - CM
			CW - CS JANUS PRO
1600	302	447	AF - CS
			CR - CM
			CW - CS JANUS PRO
1800	336	507	AF - CS
			CR - CM
			CW - CS JANUS PRO

SPR60 MIDI POIDS MACHINE 10,0 - 12,0

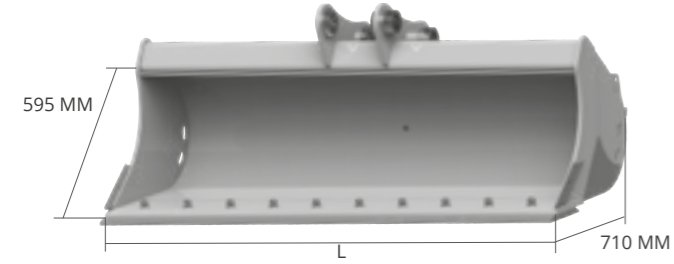

EN OPTION

- 4 VIRGULE
- 5 LAME DORSALE

L MM	POIDS KG*	CAP. SAE L	ADAPTERS
1200	273	367	AF - CS
			CR - CM - CS JANUS PRO
			CW
1400	311	436	AF - CS
			CR - CM - CS JANUS PRO
			CW
1600	351	504	AF - CS
			CR - CM - CS JANUS PRO
			CW
1800	389	573	AF - CS
			CR - CM - CS JANUS PRO
			CW
2000	427	641	AF - CS
			CR - CM - CS JANUS PRO
			CW

SPR65 HD EXCAVATOR POIDS MACHINE 12,0 - 18,0

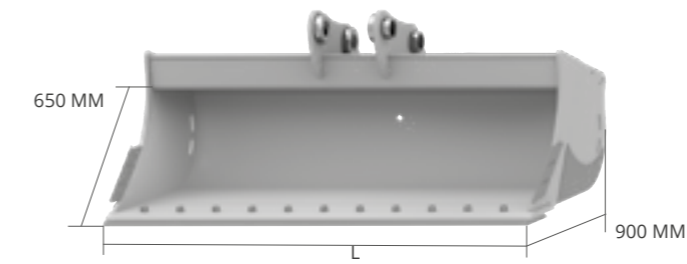

EN OPTION

- 4 VIRGULE
- 5 LAME DORSALE

L MM	POIDS KG*	CAP. SAE L	ADAPTERS
1400	394	631	AF - CM
			CS - CW
			CS JANUS PRO
1500	420	665	AF - CM
			CS - CW
			CS JANUS PRO
1600	445	699	AF - CM
			CS - CW
			CS JANUS PRO
1800	496	767	AF - CM
			CS - CW
			CS JANUS PRO
2000	546	835	AF - CM
			CS - CW
			CS JANUS PRO

* poids cuve sans attache

* poids cuve sans attache

SPR70 HD POIDS MACHINE 18,0 - 22,0

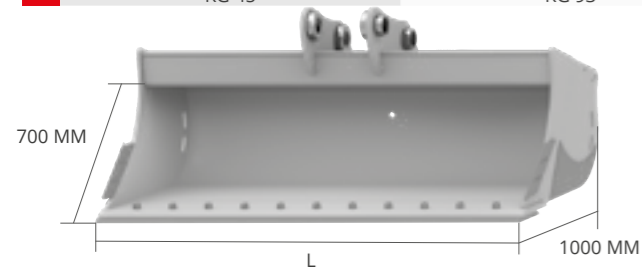
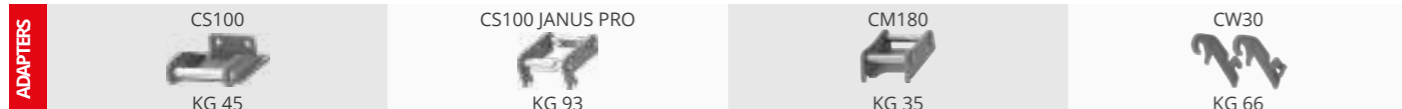

L MM	POIDS KG*	CAP. SAE L	ADAPTERS
1500	512	780	AF - CM
			CS - CW
			CS JANUS PRO
1600	543	820	AF - CM
			CS - CW
			CS JANUS PRO
1800	604	900	AF - CM
			CS - CW
			CS JANUS PRO
2000	662	980	AF - CM
			CS - CW
			CS JANUS PRO
2200	719	1060	AF - CM
			CS - CW
			CS JANUS PRO

EN OPTION

- 4 VIRGULE
- 5 LAME DORSALE



* poids cuve sans attache