

SU FORMA ALARGADA FACILITA LA DESCARGA DE MATERIALES ARCILLOSOS Y HÚMEDOS. SE UTILIZA PARA LA LIMPIEZA Y LA NIVELACIÓN DE CARRETERAS, ZANJAS Y ESCARPADAS. EL CAZO NETHERLANDS TIENE UNA HOJA DE HB400.

MOD.	SPN28	SPN35	SPN41	SPN44	SPN50	SPN55	SPN66
TONS	0,6 - 1,2	1,2 - 1,8	1,8 - 2,5	2,5 - 4,0	4,0 - 6,0	6,0 - 7,5	7,5 - 12,0

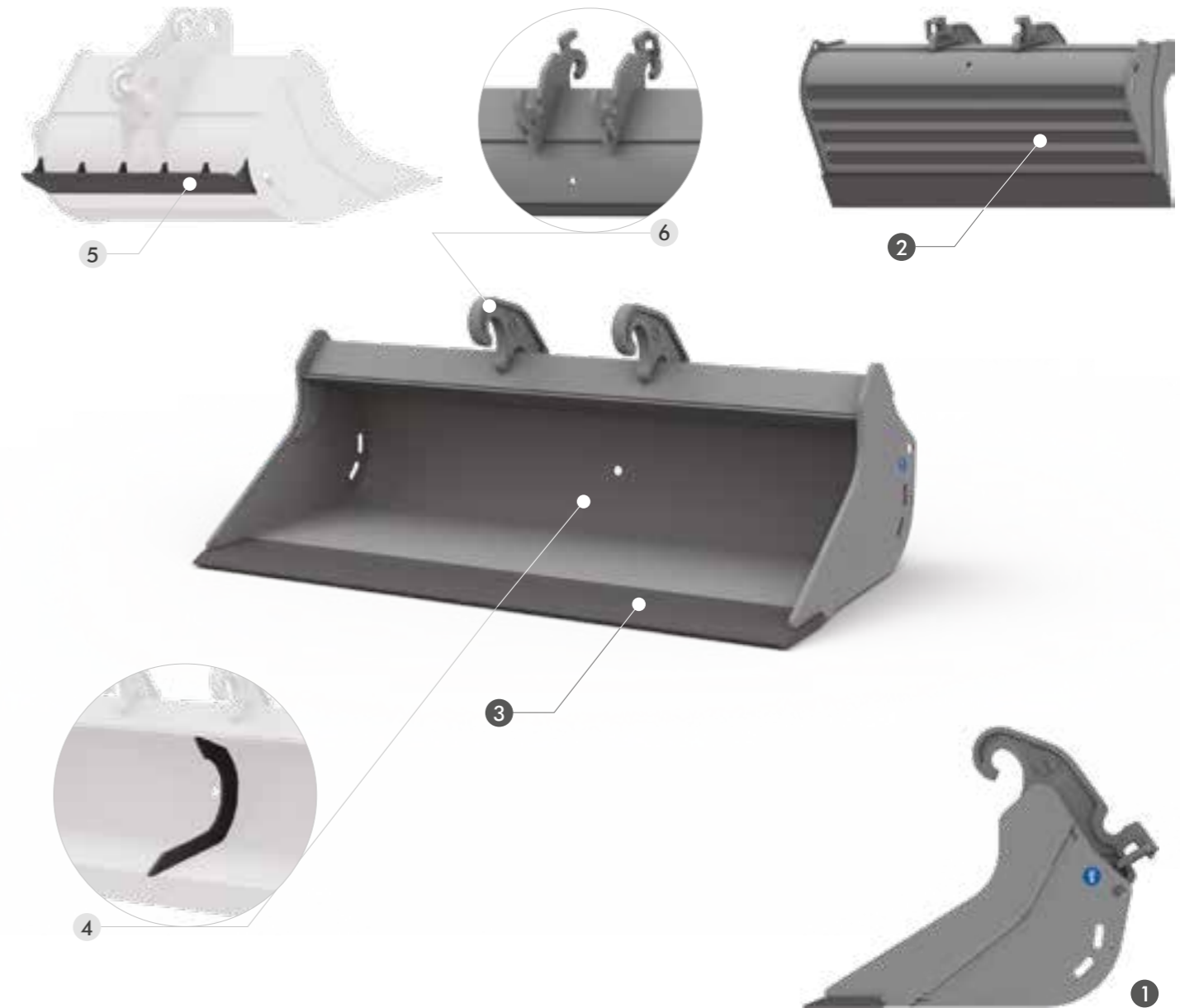

ADAPTERS



### ESTÁNDAR

**1 PERFIL ALARGADO**

**2 BANDAS DE REFUERZO**

LAS BANDAS DE REFUERZO HORIZONTALES PROTEGEN EL FONDO DEL DESGASTE, AUMENTANDO SU RESISTENCIA.

**3 CUCHILLA DE HB400**

### ACCESORIOS OPCIONALES

**4 LUNETAS**

GARANTIZA UNA MAYOR RESISTENCIA ESTRUCTURAL, POR LO QUE SE RECOMIENDA EN LOS CAZOS DE 1400 MM O MÁS DE ANCHURA.

**5 HOJA DE TERMINACIÓN TRASERA**

MANTENIENDO CERRADO EL BRAZO DE LA MÁQUINA, PERMITE TERMINAR LAS SUPERFICIES DE MANERA UNIFORME.

**6 VERSIÓN REVERSIBLE CW**

ESTE ADAPTADOR HACE QUE EL CAZO SEA REVERSIBLE.

## SPN28 PESO MÁQUINA 0,6 - 1,2

ADAPTERS

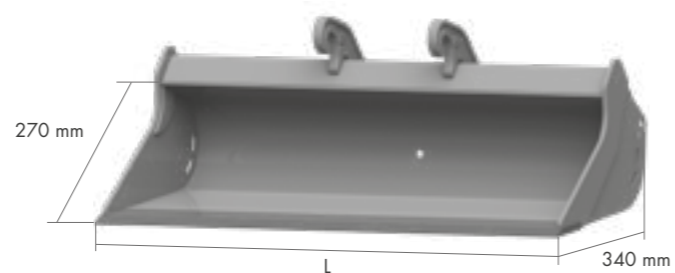

### ACCESORIOS OPCIONALES

5	6
Hoja de terminación trasera	Versión reversible CW

L mm	PESO Kg*	CAP. SAE l	ADAPTERS
600	27	35	AF
600	27	35	CW
700	31	41	AF
700	31	41	CW
800	35	47	AF
800	35	47	CW

## SPN35 PESO MÁQUINA 1,2 - 1,8

ADAPTERS

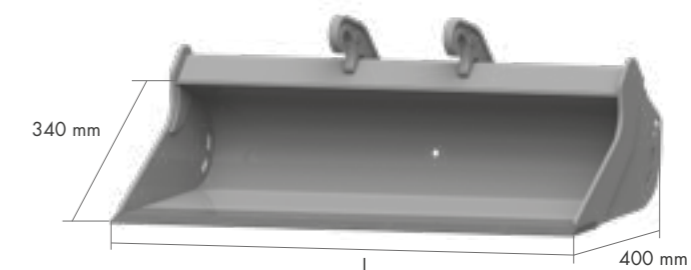

### ACCESORIOS OPCIONALES

5	6
Hoja de terminación trasera	Versión reversible CW

L mm	PESO Kg*	CAP. SAE l	ADAPTERS
800	43	77	AF
800	43	77	CW
900	48	89	AF
900	48	89	CW
1000	53	99	AF
1000	53	99	CW

## SPN41 PESO MÁQUINA 1,8 - 2,5

ADAPTERS

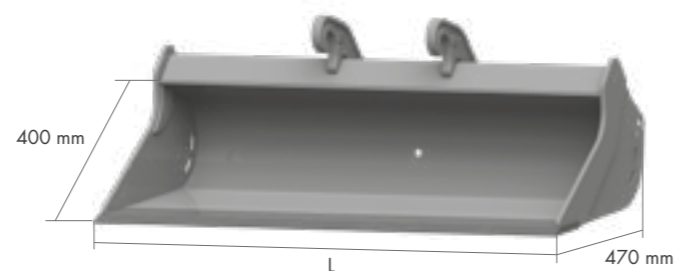
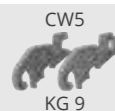

### ACCESORIOS OPCIONALES

5	6
Hoja de terminación trasera	Versión reversible CW

L mm	PESO Kg*	CAP. SAE l	ADAPTERS
900	65	95	AF
900	65	95	CW
1000	72	107	AF
1000	72	107	CW
1100	78	119	AF
1100	78	119	CW
1200	85	131	AF
1200	85	131	CW

## SPN44 PESO MÁQUINA 2,5 - 4,0

ADAPTERS

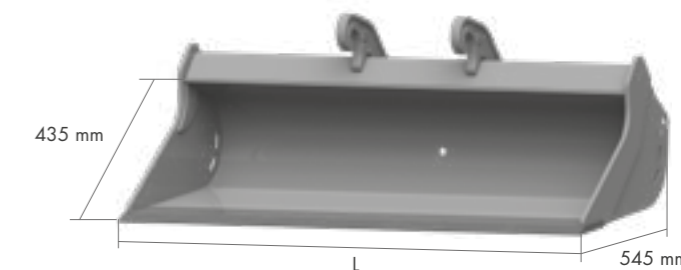

### ACCESORIOS OPCIONALES

5	6
Hoja de terminación trasera	Versión reversible CW

L mm	PESO Kg*	CAP. SAE l	ADAPTERS
1000	93	149	AF
1000	93	149	CW
1100	101	166	AF
1100	101	166	CW
1200	109	184	AF
1200	109	184	CW

\* peso cazo sin enganches

\* peso cazo sin enganches

## SPN50 PESO MÁQUINA 4,0 - 6,0

ADAPTERS

CW10



KG 23

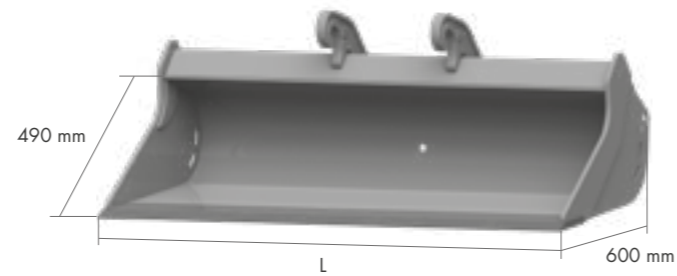

L mm	PESO Kg*	CAP. SAE l	
1000	105	192	AF
1000	105	192	CW
1100	115	215	AF
1100	115	215	CW
1200	124	238	AF
1200	124	238	CW
1300	134	261	AF
1300	134	261	CW
1400	143	284	AF
1400	143	284	CW

### ACCESORIOS OPCIONALES

4	5	6
Luneta	Hoja de terminación trasera	Versión reversible CW

## SPN55 PESO MÁQUINA 6,0 - 7,5

ADAPTERS

CW10



KG 23

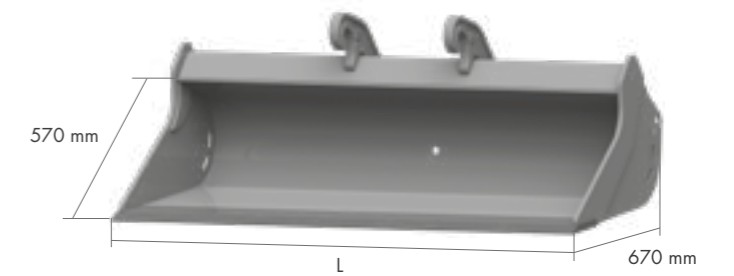

L mm	PESO Kg*	CAP. SAE l	
1200	164	283	AF
1200	164	283	CW
1300	177	311	AF
1300	177	311	CW
1400	189	341	AF
1400	189	341	CW
1500	202	368	AF
1500	202	368	CW
1600	214	396	AF
1600	214	396	CW

### ACCESORIOS OPCIONALES

4	5	6
Luneta	Hoja de terminación trasera	Versión reversible CW

## SPN66 PESO MÁQUINA 7,5 - 12,0

ADAPTERS

CW10



KG 23

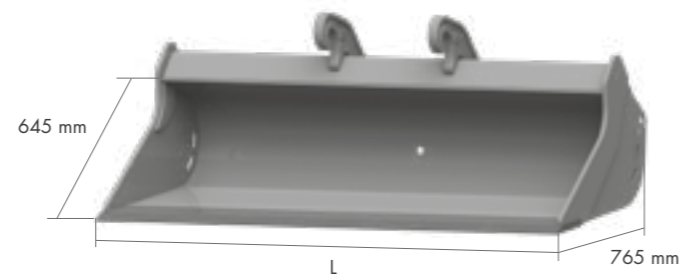

L mm	PESO Kg*	CAP. SAE l	
1400	231	459	AF
1400	231	459	CW
1500	246	498	AF
1500	246	498	CW
1600	261	537	AF
1600	261	537	CW
1700	276	575	AF
1700	276	575	CW
1800	291	614	AF
1800	291	614	CW

### ACCESORIOS OPCIONALES

4	5	6
Luneta	Hoja de terminación trasera	Versión reversible CW

\* peso cazo sin enganches

\* peso cazo sin enganches