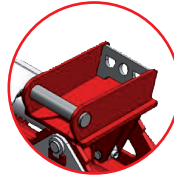

fig. 2



CR

fig. 3



CS

fig. 4



Janus

fig. 5

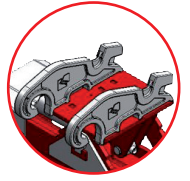

CW

SQ 60 - Fe 510 BENNE PULIZIA SCARPATE ORIENTABILI / PIVOTING DITCH CLEANING BUCKETS

A mm.	B mm.	C mm.	D mm.	Peso vasca Bucket body kg.	Cap. Sae	Attacco Attachment	Fig.
1200	605	708	787	320	367	AF	1
1200	605	708	787	320	367	CR	2
1200	605	708	787	320	367	CS	3
1200	605	708	787	320	367	Janus	4
1200	605	708	787	320	367	CW	5
1400	605	708	787	353	436	AF	1
1400	605	708	787	353	436	CR	2
1400	605	708	787	353	436	CS	3
1400	605	708	787	353	436	Janus	4
1400	605	708	787	353	436	CW	5
1600	605	708	787	385	504	AF	1
1600	605	708	787	385	504	CR	2
1600	605	708	787	385	504	CS	3
1600	605	708	787	385	504	Janus	4
1600	605	708	787	385	504	CW	5

fig. 7

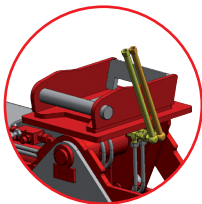

DX

fig. 8



SX

fig. 9

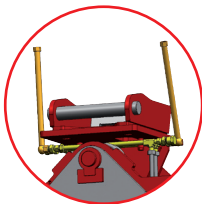

DX + SX

fig. 10

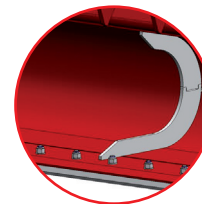

Lunetta

fig. 11



Lama
supplementare

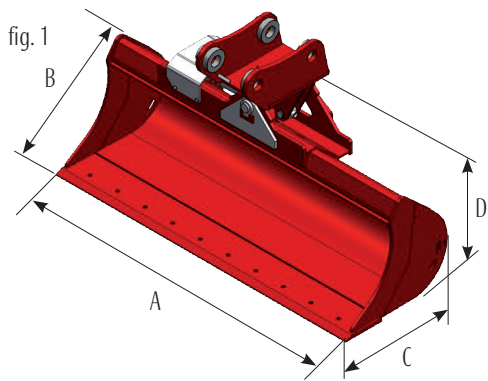
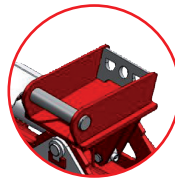

fig. 2



CR

fig. 3



CS

fig. 4



Janus

fig. 5

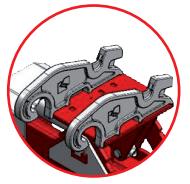

CW

SQ 60 - Fe 510 BENNE PULIZIA SCARPATE ORIENTABILI / PIVOTING DITCH CLEANING BUCKETS

A mm.	B mm.	C mm.	D mm.	Peso vasca Bucket body kg.	Cap. Sae	Attacco Attachment	Fig.
1800	605	708	787	417	573	AF	1
1800	605	708	787	417	573	CR	2
1800	605	708	787	417	573	CS	3
1800	605	708	787	417	573	Janus	4
1800	605	708	787	417	573	CW	5
2000	605	708	787	450	641	AF	1
2000	605	708	787	450	641	CR	2
2000	605	708	787	450	641	CS	3
2000	605	708	787	450	641	Janus	4
2000	605	708	787	450	641	CW	5

fig. 7

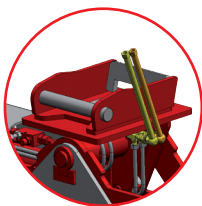

DX

fig. 8



SX

fig. 9

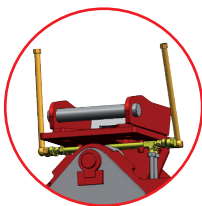

DX + SX

fig. 10

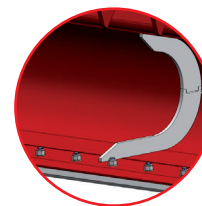

Lunetta

fig. 11



Lama
supplementare