

AR

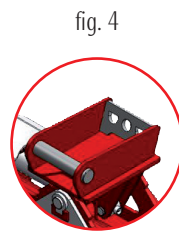

CR



CS



Janus



AF

SQN 55 BENNA PULIZIA SCARPATE ORIENTABILE OLANDA / HOLLAND PIVOTING DITCH CLEANING BUCKETS

A mm.	B mm.	C mm.	D mm.	Peso vasca Bucket body kg.	Cap. Sae	Attacco Attachment	Fig.
1200	581	672	745	272	283	CW	1
1200	581	672	745	272	283	AR	2
1200	581	672	745	272	283	CR	3
1200	581	672	745	272	283	CS	4
1200	581	672	745	272	283	Janus	5
1200	581	672	745	272	283	AF	6
1300	581	672	745	285	311	CW	1
1300	581	672	745	285	311	AR	2
1300	581	672	745	285	311	CR	3
1300	581	672	745	285	311	CS	4
1300	581	672	745	285	311	Janus	5
1300	581	672	745	285	311	AF	6
1400	581	672	745	297	341	CW	1
1400	581	672	745	297	341	AR	2
1400	581	672	745	297	341	CR	3
1400	581	672	745	297	341	CS	4
1400	581	672	745	297	341	Janus	5
1400	581	672	745	297	341	AF	6

fig. 7

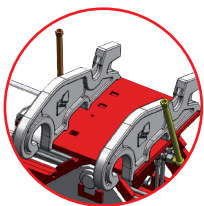

DX

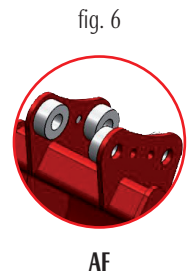
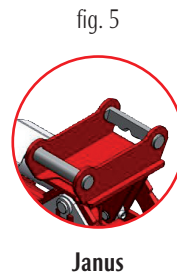
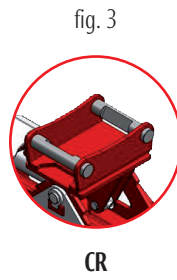
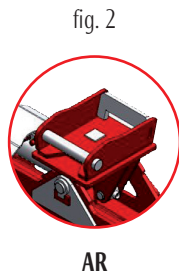
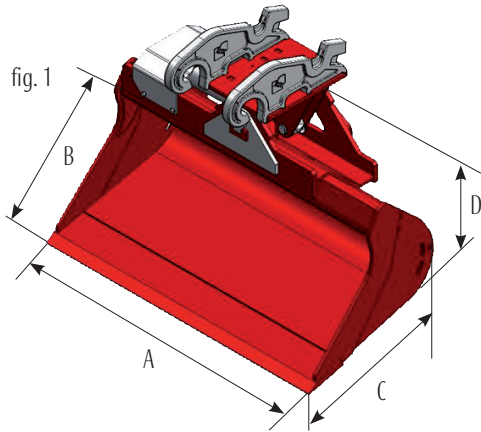

SQN 55 BENNA PULIZIA SCARPATE ORIENTABILE OLANDA / HOLLAND PIVOTING DITCH CLEANING BUCKETS

A mm.	B mm.	C mm.	D mm.	Peso vasca Bucket body kg.	Cap. Sae	Attacco Attachment	Fig.
1500	581	672	745	309	368	CW	1
1500	581	672	745	309	368	AR	2
1500	581	672	745	309	368	CR	3
1500	581	672	745	309	368	CS	4
1500	581	672	745	309	368	Janus	5
1500	581	672	745	309	368	AF	6
1600	581	672	745	322	396	CW	1
1600	581	672	745	322	396	AR	2
1600	581	672	745	322	396	CR	3
1600	581	672	745	322	396	CS	4
1600	581	672	745	322	396	Janus	5
1600	581	672	745	322	396	AF	6

fig. 7

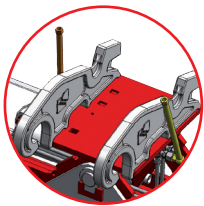

DX