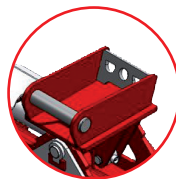

fig. 2



CR

fig. 3



CS

fig. 4



Janus

fig. 5

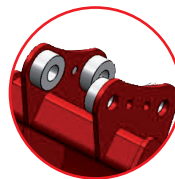

AF

SQN 66 BENNA PULIZIA SCARPATE ORIENTABILE OLANDA / HOLLAND PIVOTING DITCH CLEANING BUCKETS

A mm.	B mm.	C mm.	D mm.	Peso vasca Bucket body kg.	Cap. Sae	Attacco Attachment	Fig.
1400	655	767	820	337	459	CW	1
1400	655	767	820	337	459	CR	2
1400	655	767	820	337	459	CS	3
1400	655	767	820	337	459	Janus	4
1400	655	767	820	337	459	AF	5
1500	655	767	820	352	498	CW	1
1500	655	767	820	352	498	CR	2
1500	655	767	820	352	498	CS	3
1500	655	767	820	352	498	Janus	4
1500	655	767	820	352	498	AF	5
1600	655	767	820	367	537	CW	1
1600	655	767	820	367	537	CR	2
1600	655	767	820	367	537	CS	3
1600	655	767	820	367	537	Janus	4
1600	655	767	820	367	537	AF	5

fig. 7

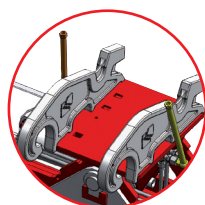

DX

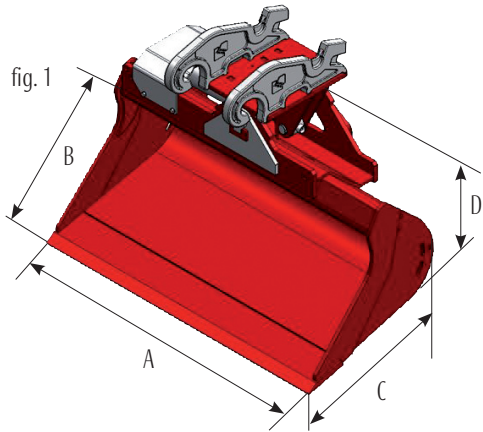

CR

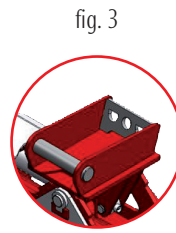

CS



Janus

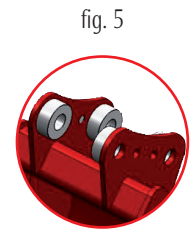

AF

SQN 66 BENNA PULIZIA SCARPATE ORIENTABILE OLANDA / HOLLAND PIVOTING DITCH CLEANING BUCKETS

A mm.	B mm.	C mm.	D mm.	Peso vasca Bucket body kg.	Cap. Sae	Attacco Attachment	Fig.
1700	655	767	820	382	575	CW	1
1700	655	767	820	382	575	CR	2
1700	655	767	820	382	575	CS	3
1700	655	767	820	382	575	Janus	4
1700	655	767	820	382	575	AF	5
1800	655	767	820	398	614	CW	1
1800	655	767	820	398	614	CR	2
1800	655	767	820	398	614	CS	3
1800	655	767	820	398	614	Janus	4
1800	655	767	820	398	614	AF	5

fig. 7

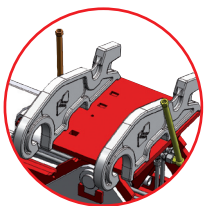

DX