

fig. 1

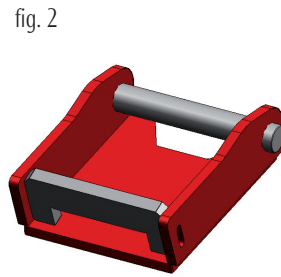

fig. 2

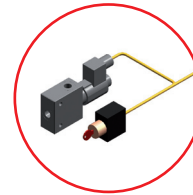

fig. 3

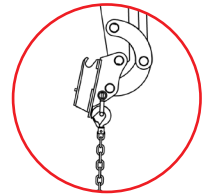

fig. 4

AR 70 FASTLOCK

FIG.	ATTACCHI RAPIDI / QUICK COUPLERS	A mm.	B mm.	peso / weight	P. max bar
1	AR 70 meccanico - mechanical	330	260	63	
1	AR 70 idraulico - hydraulic	330	260	65	250
2	Adattatore - adapter	370	262	25	
3	Kit installazione - installation kit				
4	Gancio + catena di sollevamento / lifting hook				

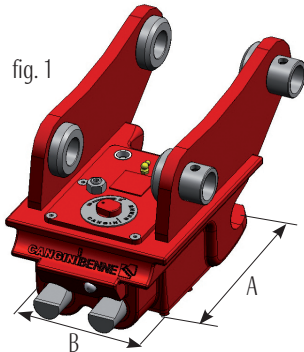

fig. 1

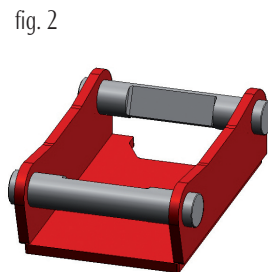

fig. 2

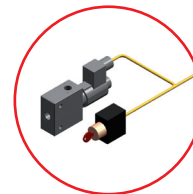

fig. 3

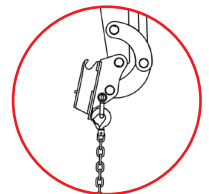

fig. 4

CR 70 TWINLOCK

FIG.	ATTACCHI RAPIDI / QUICK COUPLERS	A mm.	B mm.	peso / weight	P. max bar
1	CR 70 meccanico - mechanical	345	260	80	
1	CR 70 idraulico - hydraulic	345	260	82	250
2	Adattatore - adapter	410	262	36	
3	Kit installazione - installation kit				
4	Gancio + catena di sollevamento / lifting hook				